

ASSEMBLAGE DE STRUCTURE
PAR EMBOITEMENTS AUTOBLOQUANTS

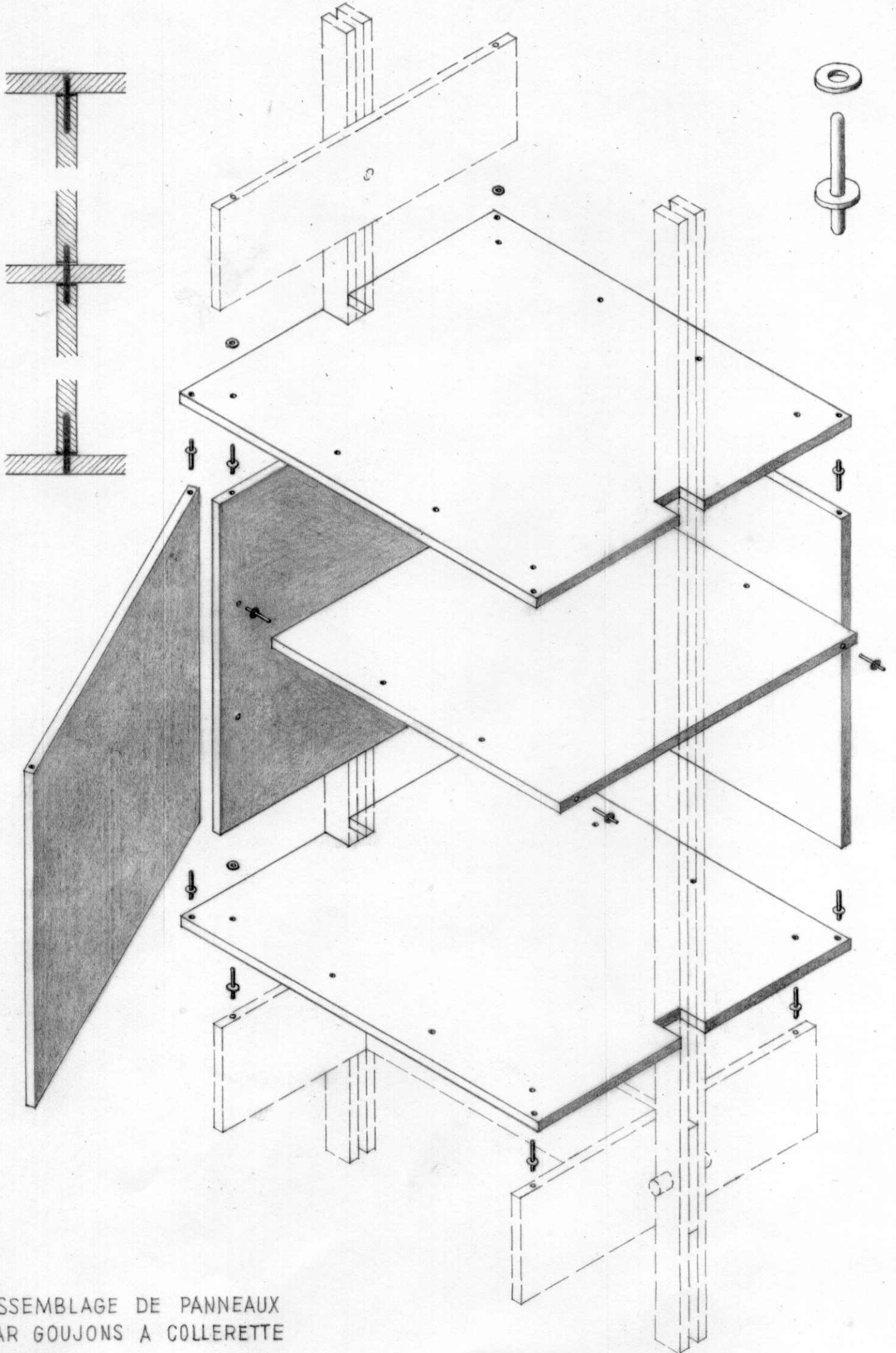

ASSEMBLAGE DE PANNEAUX
PAR GOUJONS A COLLERETTE

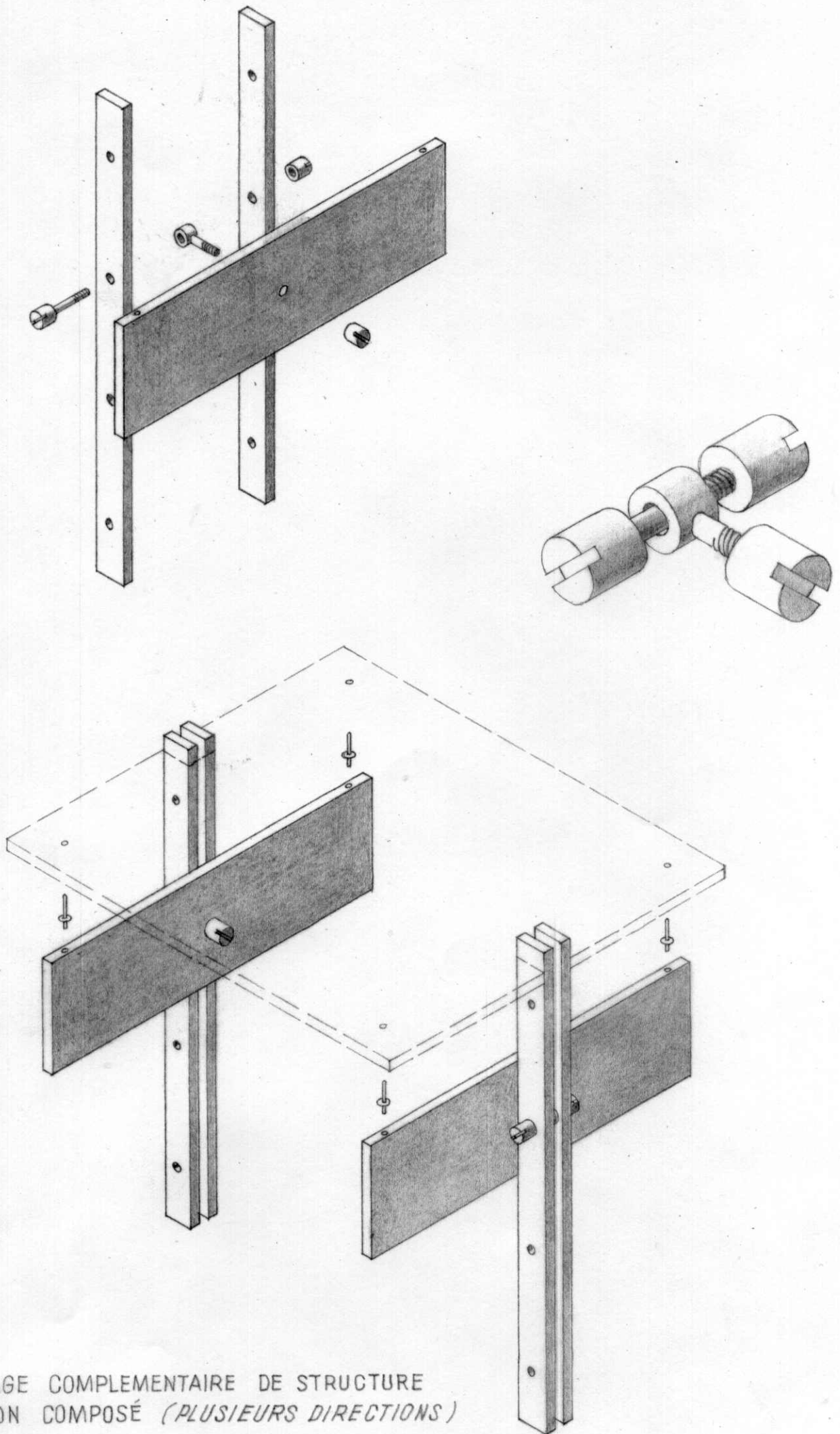

ASSEMBLAGE COMPLEMENTAIRE DE STRUCTURE
PAR BOULON COMPOSE (PLUSIEURS DIRECTIONS)

L2

L3

L5

L5c
COMPLEMENTAIRE

L8

110
110
130
150
530

FAÇADES TIROIRS CODE: FT
PERCEMENTS: VOIR PLAN N° 05

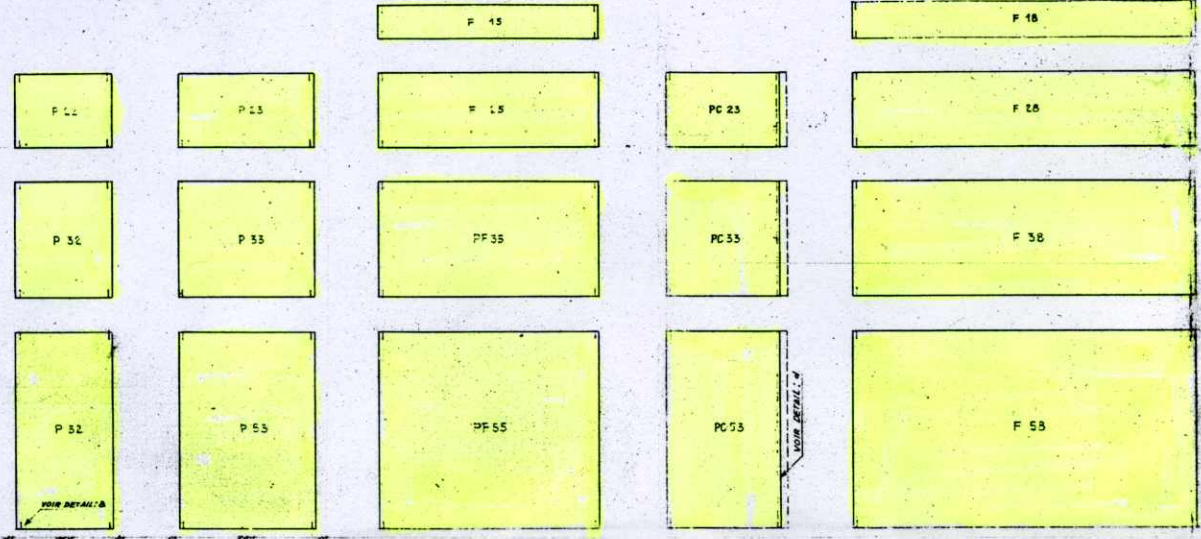

H1
H1
H2
H3
H5

PETITES PORTES CODE: P
PERCEMENTS: DETAIL: B



H8
H13

CODE:

LES DIFFERENTS PANNEAUX SONT DESIGNES PAR DES LETTRES INDICANT LEUR TYPE SUIVIES DE CHIFFRES INDICANT LEURS DIMENSIONS EN MODULES, DANS L'ORDRE: HAUTEUR: H, LARGEUR L, PROFONDEUR P

NOTA:

PANNEAUX COULEURS POUR PORTES ET FONDS

PORTES ET FONDS CODE: P&F
PERCEMENTS: DETAIL: B

LES PORTES PC DE LARGEUR L3c SONT COMPLEMENTAIRES AUX PORTES DE LARGEUR L5 POUR LES ELEMENTS DE LARGEUR L8 ELLES SONT EVENUELLEMENT COMPLEMENTAIRES AUX PETITES PORTES DE LARGEUR L2 POUR LES ELEMENTS DE LARGEUR L5

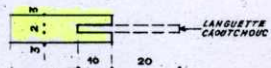

DETAIL: d
RAYURE S/CHAMP
-PORTES COMPLEMENTAIRES PC

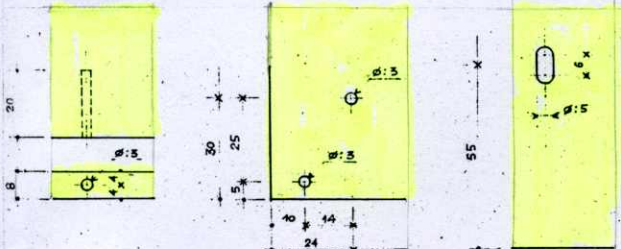

DETAIL: a
PERCEMENTS S/CHAMPS
-TABLETTES V&N
-JOURS
-PORTES
-FONDS

DETAIL: b
PERCEMENTS ANGLES
-STAGERS

DETAIL: c
TROUS OVALES
-TRAVERSES
-JOURS

COX MOBILIER "STRAM"

PLAN DES PANNEAUX FAÇONNES
EPAISSEUR UNIQUE: 8mm

N° 01
ECHELLE: 1/

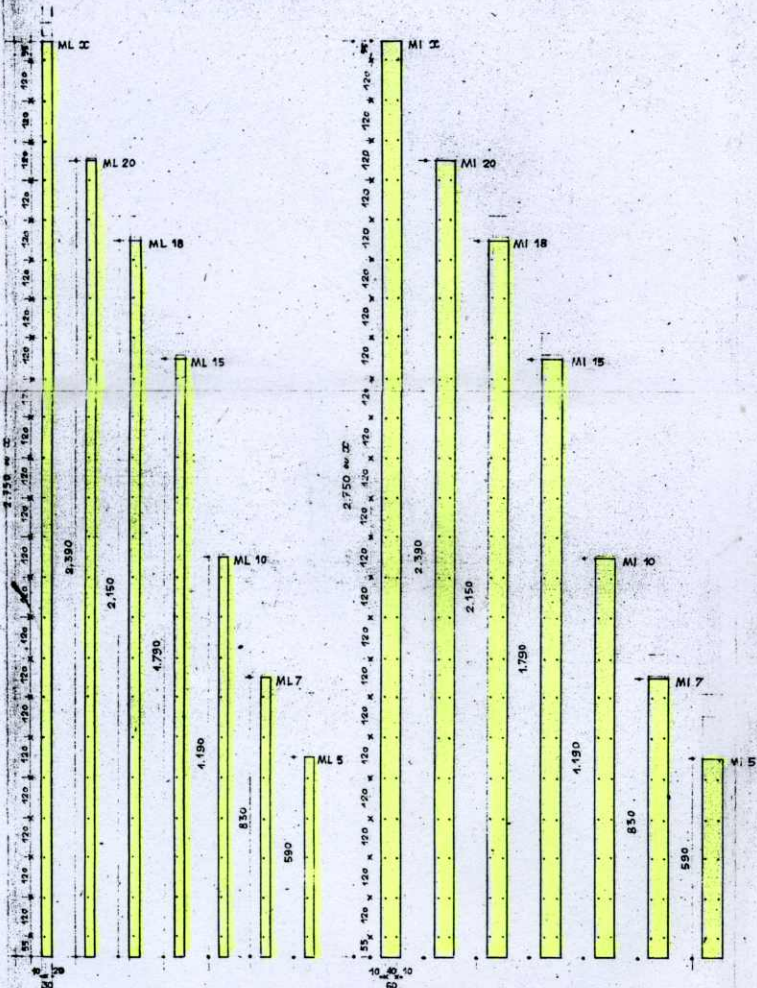

MONTANTS LATéraux CODE: ML
PERCEMENTS: TROUS Ø: 5 mm

MONTANTS INTERMÉDIAIRES CODE: MI
PERCEMENTS: TROUS Ø: 5 mm

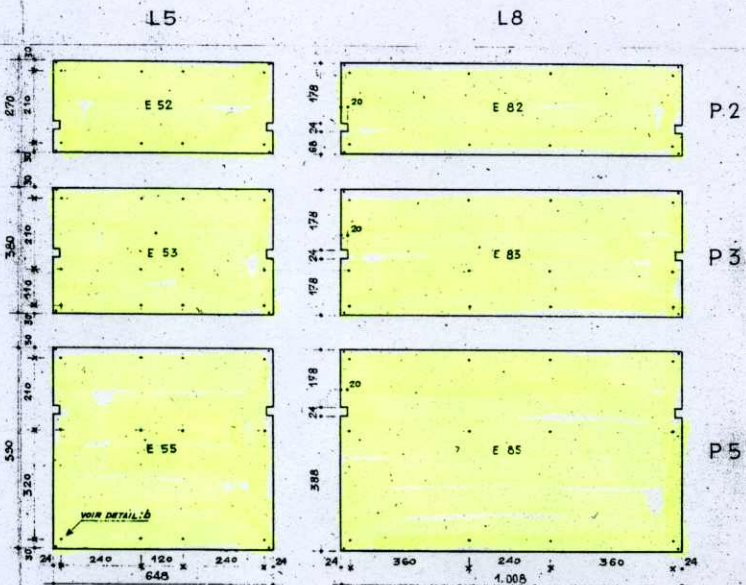

ETAGERES CODE: E
PERCEMENTS: TROUS Ø: 5 mm

NOTA

IL N'A PAS ÉTÉ TENU COMPTE DES TOLÉRANCES DE JEUX NÉCESSAIRES POUR LES ENTAILLE "À MI-BOUT" DELLES-CI SERONT AUSSI RÉDUITES QUE POSSIBLE.

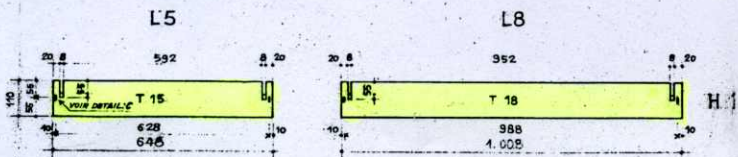

TRAVERSES CODE: T
PERCEMENTS: DETAIL: C

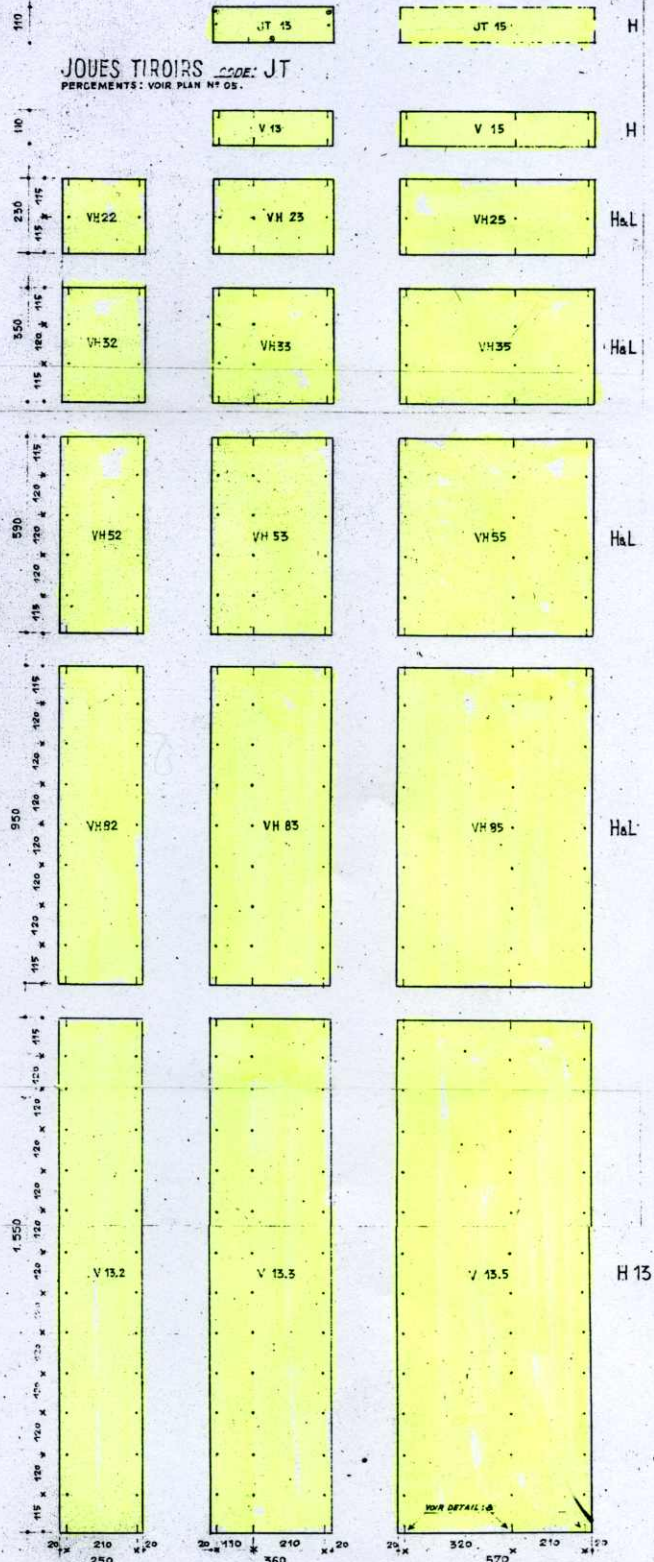

JOUES TIROIRS CODE: JT
PERCEMENTS: VOIR PLAN N° 05.

TABLETTES VERTICALES ET HORIZONTALES CODE: V&H
PERCEMENTS: TROUS Ø: 5 mm ET DETAIL: B.

JOUES CODE: J ET JOUES SPÉCIALES CODE: JS
PERCEMENTS: DETAIL: B ET DETAIL: C

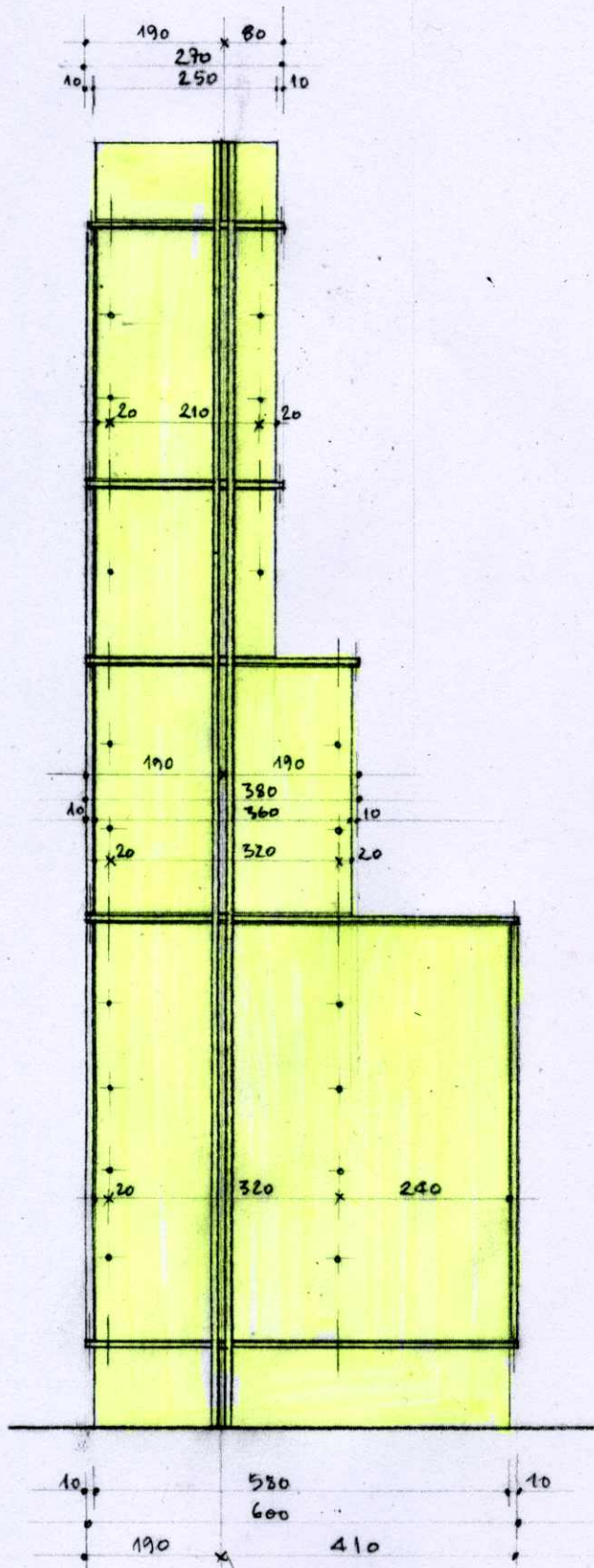

PROFIL DE PRINCIPE
LES 3 PROFONDEURS

